

VIDEO COURSES

for Government Exams



From the oldest and most trusted name in Exam Preparation which gave us Career Power, Banker-sadda, Scsadda, here is the latest offering – Video Courses that are tailor-made for the Govt. Job aspirants of digital India. Various banking and SSC exams are conducted online with regular changes to exam pattern and level of questions. We understand the changing needs of the students and have devised a unique solution, making preparation easy, cost-effective and efficient.

Video courses for Banking and SSC consist of exhaustive video lectures for government exams. We offer these courses in three variants: Online Streaming, SD Card and Android Tab + SD-Card. The SD Card can be run on your personal android device as well. The video courses will run on the Adda247 mobile app, the number one App for Bank and SSC exam preparation.



Video Course are available in

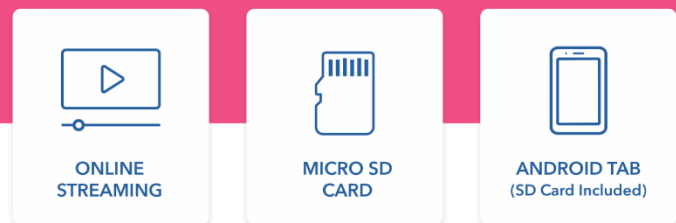

Available Courses

Banking Courses

▶ IBPS PO Pre

▶ IBPS PO Complete Kit

▶ RRB Mains Complete Kit

▶ IBPS PO Pre + Mains

▶ IBPS PO: Quantitative Aptitude

▶ IBPS RRB Pre - Quant + Reasoning

SSC Courses

▶ Maths for SSC CGL Mains

▶ English + Maths for SSC CGL Mains

▶ English for SSC CGL Mains

▶ IB ACIO (Tier I) + SSC Complete KIT

To Purchase visit : store.adda247.com

For any query : Call us at +91-90691 42412 • Email us at elarning@adda247.com

Adda247 Android App



Solutions

Solutions (1-3):

A Y E L P R S

S1. Ans.(a)

S2. Ans.(a)

S3. Ans.(b)

S4. Ans.(b)

S5. Ans.(b)

S6. Ans.(e)

Solutions (7-9):

Boxes	Colours
P	-----
-----	-----
S	Purple
-----	-----
R	-----
V	Blue
-----	Orange
-----	----
-----	----
U	----
-----	Green

S7. Ans.(b)

S8. Ans.(c)

S9. Ans.(d)

S10. Ans.(b)

Sol. There are Five meaningful words- Fair, Bowl, Blow, Cone, Once

S11. Ans.(b)

S12. Ans.(c)

 **CAREER POWER™**
AN IIT/IIM ALUMNI COMPANY

केनरा बैंक  Canara Bank

CANARA BANK PO 2018

SCALE-I

10 FULL LENGTH MOCKS

Bilingual

Solutions (13-15):

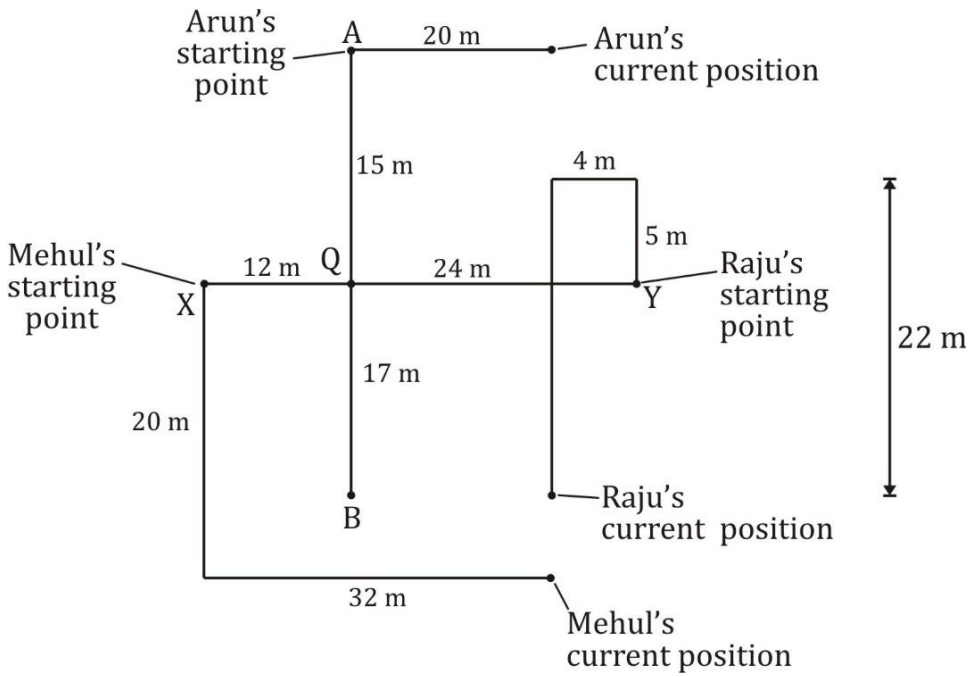

S13. Ans.(c)

S14. Ans.(c)

S15. Ans.(a)

S16. Ans.(c)

Sol.

I.

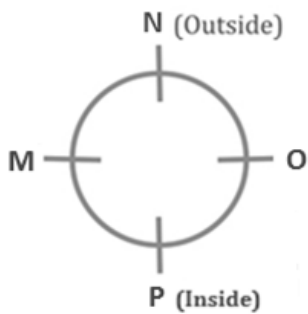

II.

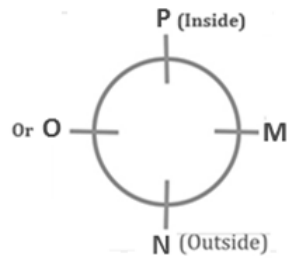
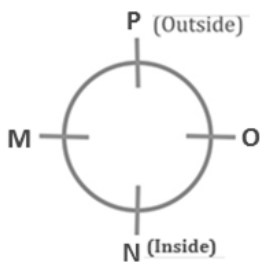

III.

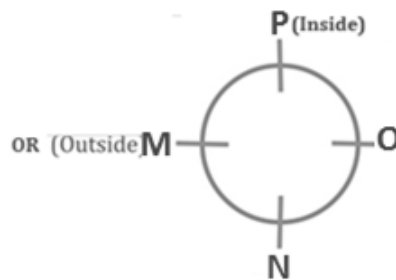
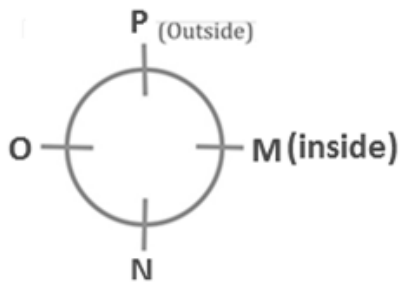

I, II or III statement alone are sufficient to conclude that M, N, O and P are all not facing to centre of table.

S17. Ans.(c)

Sol. From II and III-

6. A

5. E

4. C

3. D

2. B

1. F

It is clear that F is living on the Ground floor

S18. Ans.(d)

Sol.

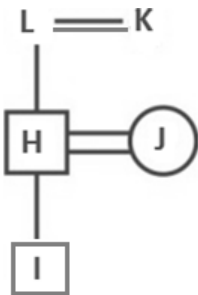

From statements II and III, I is the youngest because G is not youngest.

Solutions (19-21):

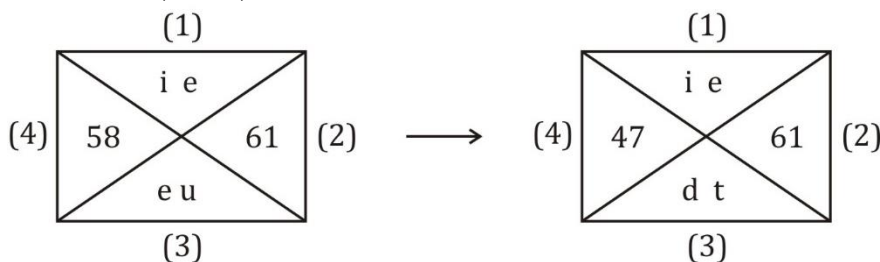

S19. Ans.(c)

S20. Ans.(b)

S21. Ans.(c)

Solutions (22-24):

In this new pattern coding decoding question only one word and one number is arranged in each step.

Let us understand the logic behind it- In each step the words and numbers are arranged from the left end.

For words- The word which comes first according to alphabetical series is arranged first and different arrangement is used in different step.

Step 1 and 2- first and second letter are interchanged and third and fourth letter are interchanged

Step 3 and 4- second and fourth letter are interchanged and rests are same.

Step 5- First letter is unchanged, second letter is shifted to fourth place, third letter is shifted to second place, fourth letter is shifted to third place.

For numbers- Numbers start arranging as the highest number is arranged in 1st step then second highest number in second step and so on from left end after each word. And in the final step all the numbers are arranged in increasing order from left end.

Input- 54 roll 39 back 87 25 cash seat 46 beat

Step I- abkc 87 54 roll 39 25 cash seat 46 beat

Step II- eata 54 abkc 87 roll 39 25 cash seat 46

Step III- chsa 46 eata 54 abkc 87 roll 39 25 seat

Step IV- rllo 39 chsa 46 eata 54 abkc 87 25 seat

Step V- sate 25 rllo 39 chsa 46 eata 54 abkc 87

S22. Ans.(c)

S23. Ans.(c)

S24. Ans.(b)

S25. Ans.(b)

Sol. Even number is followed by an odd prime number so = $6 + 5 = 11$

Then 1 row - 11 2

Odd number is followed by an even number so = $11 * 2 = 22$ (resultant of first row)

In row 2 Odd number is followed by a perfect square so = $11 - 4 = 7$

Then 2 row- 7 3

Odd number is followed by an odd number so = $7 + 3 = 10$ (resultant of second row)

So, the sum of both row = $22 + 10 = 32$

S26. Ans.(b)

Sol. Even number is followed by an prime odd number so = $14 + 7 = 21$

The row is 21 5

Odd number is followed by an another odd number so = $21 + 5 = 26$ (resultant of 1 row)

The resultant of the rows is 44 so the sum of second row = $44 - 26 = 18$

Even number is followed by X and X is followed by 6

When X = 9, then this condition can be satisfied.

S27. Ans.(d)

Sol. Odd number is followed by a perfect square so $=7-4=3$

Odd number is followed by an even number so $=3*8=24$ (resultant of 1st row)

Odd number is followed by a perfect square so $=11-9=2$

Even number is followed by an odd prime number so $=2+13=15$ (resultant of 2nd row)

So, the difference is $=24-15=9$

Solutions (28-30):

Doctors	Meeting hour
Ophthalmologist	7:00 - 8:30 am
Psychiatrist	8:30 - 10:00 am
General physician	10:00- 12:30 am
Orthopedic surgeon	12:30- 3:00 pm
Dentist	3:00- 6:00 pm

S28. Ans.(d)

S29. Ans.(b)

S30. Ans.(d)

Solutions (31-33):

FLOOR	FLAT-1	FLAT-2	FLAT-3
THIRD	L	R	P
SECOND	O	K	M
FIRST	Q	A	N

or

FLOOR	FLAT-1	FLAT-2	FLAT-3
THIRD	L	R	P
SECOND	O	A	M
FIRST	Q	K	N

S31. Ans.(d)

S32. Ans.(a)

S33. Ans.(c)

S34. Ans.(b)

Sol.

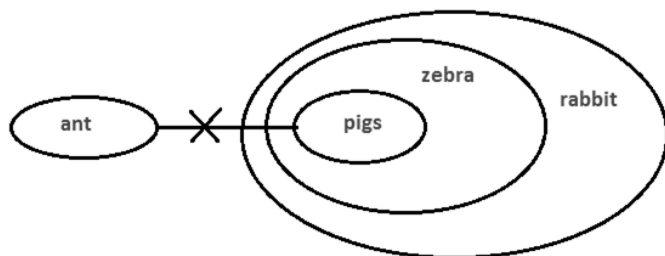

S35. Ans.(a)

Sol.

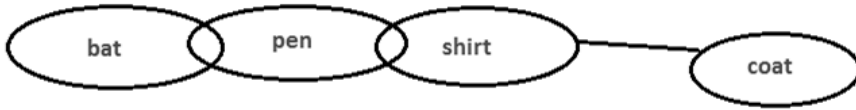

S36. Ans.(b)

Sol.



S37. Ans.(c)

Sol.

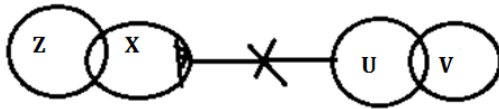

Solutions (38-40):

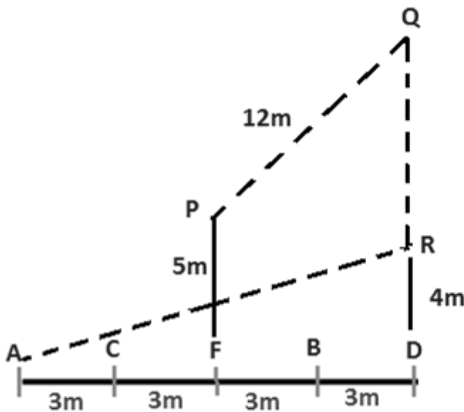

S38. Ans.(d)

S39. Ans.(b)

S40. Ans.(c)

S41. Ans.(a)

Sol. In the statement it is given that army should be deployed to rehabilitate the people displaced due to earthquake. It means that army can be used for purposes other than war also. So, assumption I is implicit. Assumption II is not implicit because the word 'only' is making it baseless as there may be some other measures which can rehabilitate the displaced victims of earthquake.

S42. Ans.(b)

Sol. A child can learn before he/she turns five. So, assumption I is not implicit. Some schools admit children who are below five years of age, so government gives that advertisement. So, assumption II is implicit.

S43. Ans.(b)

Sol. Course of action I does not follow due to the words 'all' and 'immediate'. Course of action II follows because a system should be implemented to certify the quality of tiffin provided by the school.

S44. Ans.(e)

Sol. Both the actions follow because adequate police force should be deployed and vehicles on the road should be advised a diversion to avoid traffic congestion.

Solutions (45-48):

Step 1.

Floor	Person	Blood group	Grade
8	P	AB+	A
7	O	A+	B
6	N	AB-	E
5	M	O+	F
4	L	B+	C
3	K	A-	D
2	J	O-	G
1	Q	B-	H

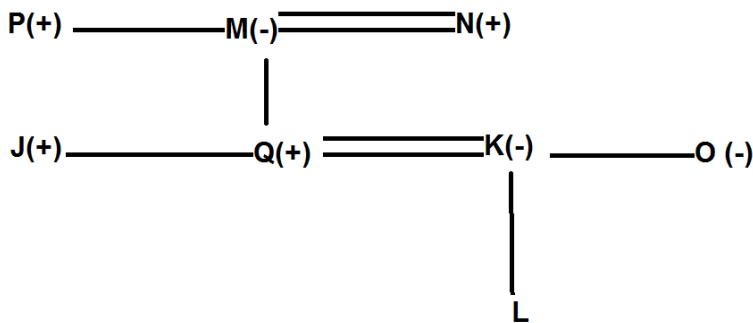

S45. Ans.(a)

S46. Ans.(d)

S47. Ans.(c)

S48. Ans.(d)

S49. Ans.(e)

Sol. (a) does not follow because the NCR phenomenon can't be extrapolated to "most of the big cities". (b) and (d) are probable consequences. (c) shows us the other side. (e) follows from the mention of "slump in home sales" and scope for "price correction".

S50. Ans.(a)

Sol. Note that the statement conveys to us that the delay in compensation is now a thing of the past. We can't infer about the specifics- 'insurance company' in statement (c) and 'IRCTC' in statement (d).

Have a Coaching Institute?

Be a Adda247 Partner and take your institute to new heights.

partners.adda247.com



VIDEO COURSE

Compliment your classroom with Banking Video Courses
visit: videocourses.adda247.com

Study on the GO with the Adda247 App

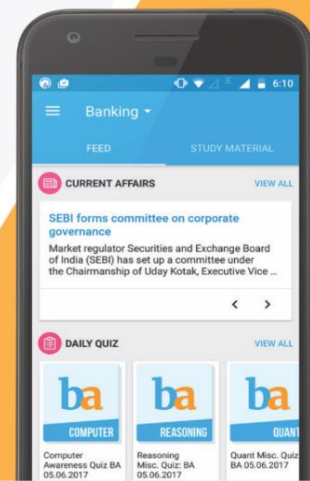

Boost your prep with Topic-wise E-books and monthly Magazines
visit: store.adda247.com



Fulfill your Dream of **Government Job** visit: careerpower.in