



RAILWAY RECRUITMENT BOARDS

रेलवे भर्ती बोर्ड

2nd Stage CBT for ALP & TECHNICIANS (CEN-01/2018)

Roll No:	
Participants Name:	
Test Center Name:	
Test Date:	23/01/2019
Test Time:	12:30 PM - 3:00 PM
Subject:	Part A and Exam Trade : Electronics Mechanic

- Options shown in green color with a tick icon are correct
- Chosen option on top right of the question indicates the option selected by the candidate
- The numbers indicated against the Question ID and Option ID are the numbers to be noted and used for raising objections

Section : Part A

Q.1 The sum of binary numbers 1100100 and 1101110 is _____.

- Ans
- 1. 11110010
 - 2. 11010010
 - 3. 11100110
 - 4. 11001000

Question ID : 7079669327
Option 1 ID : 70796637308
Option 2 ID : 70796637307
Option 3 ID : 70796637305
Option 4 ID : 70796637306

Status : Answered
Chosen Option : 2

Q.2 A company has six departments. The given bar graph shows the number of employees in each department for the years 2015 and 2018. The company added 80 new employees and fired some employees between the years 2015 and 2018. All the employees who were fired were from department C. If the employees of department C had NOT been fired, then the employee strength of department C in 2018 would have been greater by _____.

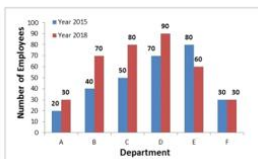

- Ans
- 1. 12.5%
 - 2. 10%
 - 3. 20%
 - 4. 17.5%

Question ID : 7079669370

Option 1 ID : 70796637478
Option 2 ID : 70796637477
Option 3 ID : 70796637480
Option 4 ID : 70796637479
Status : Answered
Chosen Option : 2

Q.3 If A \$ B means A is the sister of B, A # B means A is the husband of B and A * B means A is the daughter of B, then what does P \$ Q * R # S mean?

- Ans
- 1. S is the sister-in-law of P.
 - 2. S is the grandmother of P.
 - 3. S is the sister of P.
 - 4. S is the mother of P.

Question ID : 7079669359
Option 1 ID : 70796637434
Option 2 ID : 70796637435
Option 3 ID : 70796637433
Option 4 ID : 70796637436
Status : Answered
Chosen Option : 4

Q.4 Which of the following nations is NOT a permanent member of the United Nations Security Council?

- Ans
- 1. Germany
 - 2. China
 - 3. United Kingdom
 - 4. France

Question ID : 7079669277
Option 1 ID : 70796637105
Option 2 ID : 70796637108
Option 3 ID : 70796637107
Option 4 ID : 70796637106
Status : Answered
Chosen Option : 1

Q.5 Which of the following folk dances is from Himachal Pradesh?

- Ans
- 1. Giddha
 - 2. Nati
 - 3. Lezim
 - 4. Bagurumba

Question ID : 7079669285
Option 1 ID : 70796637138
Option 2 ID : 70796637139
Option 3 ID : 70796637140
Option 4 ID : 70796637137
Status : Not Answered
Chosen Option : --

Q.6 The sentences given in this question, when properly sequenced, form a coherent paragraph. Each sentence is labelled with a letter (the first sentence is not labelled and given for your reference). Choose the most logical order of sentences from among the given choices to construct a coherent paragraph.

There were once two brothers who lived on the edge of a forest.

A: One day, the elder brother went into the forest to find some firewood to sell in the market.

B: As he went around chopping the branches of a tree after tree, he came upon a magical tree.

C: The elder brother was very mean to his younger brother and ate up all the food and took all his good clothes.

D: The tree said to him, 'Oh kind sir, please do NOT cut my branches.'

- Ans
- 1. ACDB
 - 2. CABD
 - 3. ACBD
 - 4. CADB

Question ID : 7079669373

Option 1 ID : 70796637492

Option 2 ID : 70796637489

Option 3 ID : 70796637491

Option 4 ID : 70796637490

Status : Answered

Chosen Option : 2

Q.7 Find the efficiency of a pump (rated 400 W) that can lift 500 kg of water by 30 m in 10 minutes. (Use $g = 10\text{m/s}^2$)

- Ans
- 1. 62.50%
 - 2. 77.50%
 - 3. 84.00%
 - 4. 92.00%

Question ID : 7079669286

Option 1 ID : 70796637143

Option 2 ID : 70796637142

Option 3 ID : 70796637141

Option 4 ID : 70796637144

Status : Not Answered

Chosen Option : --

Q.8 What is the angle between the hour hand and the minute hand of a clock at quarter past three?

- Ans
- 1. 8.5°
 - 2. 9.5°
 - 3. 6.5°
 - 4. 7.5°

Question ID : 7079669349

Option 1 ID : 70796637394

Option 2 ID : 70796637396

Option 3 ID : 70796637393

Option 4 ID : 70796637395

Status : Not Answered

Chosen Option : --

Q.9 Breathing in about 900 parts of _____ in a million parts of air for a short time causes fatigue, dizziness, and headache.

- Ans
- 1. chloroform

- 2. pesticides
- 3. asbestos particles
- 4. arsenic

Question ID : 7079669294
Option 1 ID : 70796637174
Option 2 ID : 70796637176
Option 3 ID : 70796637173
Option 4 ID : 70796637175
Status : Answered
Chosen Option : 1

Q.1 In this question, two statements are given, followed by three conclusions labelled I, II and III. You have to consider the statements to be true even if they seem to be at variance with commonly known facts, and decide which of the given conclusions, if any, follow(s) from the given statements.

Statements:

All mansions are palaces.
No castles are palaces.

Conclusions:

I: Some palaces are mansions.
II: Some castles are mansions.
III: No mansions are castles.

- Ans**
- 1. Only conclusion III follows.
 - 2. Only conclusion I follows.
 - 3. Only conclusion I and III follow.
 - 4. All the conclusions, I, II and III, follow.

Question ID : 7079669364
Option 1 ID : 70796637454
Option 2 ID : 70796637453
Option 3 ID : 70796637455
Option 4 ID : 70796637456
Status : Answered
Chosen Option : 2

Q.1 Which of the following gives the correct relation between power 'P', resistance 'R' and charge 'Q' flowing through a wire in 't' seconds?

- Ans**
- 1. $PQ = IRt$
 - 2. $PI = QRt$
 - 3. $PR = QIt$
 - 4. $Pt = IRQ$

Question ID : 7079669289
Option 1 ID : 70796637153
Option 2 ID : 70796637155
Option 3 ID : 70796637156
Option 4 ID : 70796637154
Status : Answered
Chosen Option : 1

Q.1 In a certain gear train, the driver has 24 teeth while the follower has 8 teeth. For every _____ turns of the driver, the
2 follower turns 36 times.

- Ans 1. 12
 2. 4
 3. 9
 4. 10

Question ID : 7079669293
Option 1 ID : 70796637170
Option 2 ID : 70796637169
Option 3 ID : 70796637172
Option 4 ID : 70796637171
Status : Not Answered
Chosen Option : --

Q.1 Two numbers are 10% and 20% less than a third number. By what percentage should the second number be increased to
3 make it equal to the first number?

- Ans 1. 12.5%
 2. 10%
 3. 8%
 4. 7.5%

Question ID : 7079669333
Option 1 ID : 70796637331
Option 2 ID : 70796637329
Option 3 ID : 70796637330
Option 4 ID : 70796637332
Status : Not Answered
Chosen Option : --

Q.1 Find the mass (in kg) of kerosene filled up to the brim in a tank of dimensions $5\text{ m} \times 2\text{ m} \times 1\text{ m}$. (Density of kerosene is
4 800 kg/m^3)

- Ans 1. 12,500
 2. 8,000
 3. 800
 4. 1,250

Question ID : 7079669291
Option 1 ID : 70796637164
Option 2 ID : 70796637163
Option 3 ID : 70796637161
Option 4 ID : 70796637162
Status : Answered
Chosen Option : 2

Q.1 Find the value of:
5

$$16 - (25\% \text{ of } (14 \times 10 \div 35 + 12 \times 10 \div 15))$$

- Ans 1. 13
 2. 7

3. 11

4. 9

Question ID : 7079669328

Option 1 ID : 70796637312

Option 2 ID : 70796637311

Option 3 ID : 70796637309

Option 4 ID : 70796637310

Status : Answered

Chosen Option : 1

Q.1 A _____ projection is an oblique projection in which the depth of the object is shown in full size.

Ans 1. cavalier

2. fisheye

3. orthographic

4. perspective

Question ID : 7079669300

Option 1 ID : 70796637199

Option 2 ID : 70796637200

Option 3 ID : 70796637198

Option 4 ID : 70796637197

Status : Answered

Chosen Option : 2

Q.1 Pipe A can fill a tank in 12 hours. Pipe B can empty it in X hours. If both the pipes are opened together, then the tank will be filled in 30 hours. Find X.

Ans 1. 25

2. 15

3. 24

4. 20

Question ID : 7079669350

Option 1 ID : 70796637398

Option 2 ID : 70796637397

Option 3 ID : 70796637399

Option 4 ID : 70796637400

Status : Not Answered

Chosen Option : --

Q.1 Which element is mostly provided by grains, nuts and chocolates in our diet?

Ans 1. Iodine

2. Chloride

3. Copper

4. Zinc

Question ID : 7079669322

Option 1 ID : 70796637286

Option 2 ID : 70796637287

Option 3 ID : 70796637288
Option 4 ID : 70796637285
Status : Answered
Chosen Option : 4

Q.1
9 Amit calculated $\frac{2}{5}$ th of a number instead of calculating $\frac{2}{15}$ th. His answer was greater than the correct answer by 336.
Find the number.

- Ans
- 1. 1344
 - 2. 1008
 - 3. 1260
 - 4. 1680

Question ID : 7079669330
Option 1 ID : 70796637320
Option 2 ID : 70796637319
Option 3 ID : 70796637318
Option 4 ID : 70796637317
Status : Not Answered
Chosen Option : --

Q.2
0 A statement is given, followed by two conclusions. Decide which of the given conclusions logically follow(s) from the given statement.

Statement:

Emotional Quotient is a good predictor of success in career.

Conclusions:

I: The top 10 employees in a division will have the top 10 Emotional Quotients.

II: Finding the Emotional Quotient of a candidate will give the hiring company extra useful information.

- Ans
- 1. Only conclusion I follows.
 - 2. Neither conclusion I nor II follows.
 - 3. Both conclusions I and II follow.
 - 4. Only conclusion II follows.

Question ID : 7079669375
Option 1 ID : 70796637497
Option 2 ID : 70796637499
Option 3 ID : 70796637500
Option 4 ID : 70796637498
Status : Answered
Chosen Option : 4

Q.2
1 If 90 J of work is done in moving a charge of 2,000 coulombs across V volts, find V.

- Ans
- 1. 0.2
 - 2. 2,250
 - 3. 180
 - 4. 0.045

Question ID : 7079669311
Option 1 ID : 70796637244
Option 2 ID : 70796637243

Option 3 ID : 70796637242
Option 4 ID : 70796637241
Status : Answered
Chosen Option : 4

Q.2
2 What is the area (in cm^2) of a regular hexagon of side 10 cm?

- Ans
- 1. $300\sqrt{3}$
 - 2. $75\sqrt{3}$
 - 3. $150\sqrt{3}$
 - 4. $450\sqrt{3}$

Question ID : 7079669334
Option 1 ID : 70796637335
Option 2 ID : 70796637333
Option 3 ID : 70796637334
Option 4 ID : 70796637336
Status : Not Answered
Chosen Option : --

Q.2
3 Find the heat capacity of a steel vessel of mass 2.5 kg if its temperature rises by 10 degrees. Specific heat capacity of steel is $500 \text{ Jkg}^{-1}\text{K}^{-1}$.

- Ans
- 1. $200 \text{ Jkg}^{-1}\text{K}^{-1}$
 - 2. 125 JK^{-1}
 - 3. $1,250 \text{ JK}^{-1}$
 - 4. $20 \text{ Jkg}^{-1}\text{K}^{-1}$

Question ID : 7079669307
Option 1 ID : 70796637226
Option 2 ID : 70796637227
Option 3 ID : 70796637225
Option 4 ID : 70796637228
Status : Answered
Chosen Option : 4

Q.2
4 The hotel Taj Lake Palace, built in the middle of Lake Pichola, is in which city?

- Ans
- 1. Udaipur
 - 2. Jodhpur
 - 3. Bikaner
 - 4. Jaipur

Question ID : 7079669283
Option 1 ID : 70796637129
Option 2 ID : 70796637130
Option 3 ID : 70796637132
Option 4 ID : 70796637131
Status : Not Answered
Chosen Option : --

Q.2 The ratio of the present ages of Leela and her mother is 3:8. The mother was 25 years old when Leela was born. Find
5 the mother's present age (in years).

- Ans 1. 40
 2. 52
 3. 56
 4. 48

Question ID : 7079669348
Option 1 ID : 70796637390
Option 2 ID : 70796637392
Option 3 ID : 70796637391
Option 4 ID : 70796637389
Status : Answered
Chosen Option : 1

Q.2 If a vendor sells a coconut at ₹32, he incurs a 20% loss. What is the cost price of the coconut?
6

- Ans 1. ₹48
 2. ₹40
 3. ₹44
 4. ₹36

Question ID : 7079669340
Option 1 ID : 70796637360
Option 2 ID : 70796637358
Option 3 ID : 70796637359
Option 4 ID : 70796637357
Status : Answered
Chosen Option : 2

Q.2 In a certain code, EXACT is written as 91685 and MILK is written as 7243. Using the same code, MELT will be written
7 as _____.

- Ans 1. 5384
 2. 7945
 3. 8794
 4. 9285

Question ID : 7079669355
Option 1 ID : 70796637417
Option 2 ID : 70796637420
Option 3 ID : 70796637418
Option 4 ID : 70796637419
Status : Answered
Chosen Option : 2

Q.2
8

One statement is given followed by two assumptions labelled I and II. You have to consider the statement to be true, even if it seems to be at variance with commonly known facts, and decide which of the given assumptions is/are implicit in the given statement.

Statement:

'Height should be between 5 feet 6 inches and 6 feet.' – One of the conditions for recruiting fighter pilots.

Assumptions:

- I. Fighter pilots should be presentable as they are role models for the young.
II. Only certain body types can fit in a fighter plane cockpit.

- Ans 1. Only assumption II is implicit.
 2. Both assumptions I and II are implicit.
 3. Neither assumption I nor II is implicit.
 4. Only assumption I is implicit.

Question ID : 7079669369
Option 1 ID : 70796637474
Option 2 ID : 70796637476
Option 3 ID : 70796637475
Option 4 ID : 70796637473
Status : Answered
Chosen Option : 1

Q.2
9 Choose the word that is different from the rest.

- Ans 1. Pool
 2. Lake
 3. Stream
 4. Pond

Question ID : 7079669367
Option 1 ID : 70796637467
Option 2 ID : 70796637466
Option 3 ID : 70796637468
Option 4 ID : 70796637465
Status : Answered
Chosen Option : 3

Q.3
0 A alone can paint a wall in 50 days and B alone can do it in 10 days. If A, B and C together can paint the wall in 6.25 days, then in how many days can C alone paint the wall?

- Ans 1. 20
 2. 25
 3. 40
 4. 15

Question ID : 7079669337
Option 1 ID : 70796637345
Option 2 ID : 70796637348
Option 3 ID : 70796637347
Option 4 ID : 70796637346
Status : Not Answered
Chosen Option : --

Q.3
1 Two litres of superheated water at 190°C is mixed with six litres of cold water at 20°C. Find the final equilibrium temperature (in °C) if no heat is lost.

- Ans
- 1. 47.5
 - 2. 95
 - 3. 55
 - 4. 62.5

Question ID : 7079669316
Option 1 ID : 70796637262
Option 2 ID : 70796637264
Option 3 ID : 70796637263
Option 4 ID : 70796637261
Status : Not Answered
Chosen Option : --

Q.3
2 Paracetamol is found in first-aid boxes. When/why should these drugs be taken?

- Ans
- 1. To bring relief from asthma.
 - 2. To ease mild pain and reduce high temperature (fever).
 - 3. To ease indigestion and heartburn.
 - 4. To ease the symptoms of hay fever and other allergies.

Question ID : 7079669317
Option 1 ID : 70796637266
Option 2 ID : 70796637268
Option 3 ID : 70796637267
Option 4 ID : 70796637265
Status : Answered
Chosen Option : 2

Q.3
3 Solve the following.

$$\sqrt{0.2025} + \sqrt{0.12225} = \underline{\hspace{2cm}}$$

- Ans
- 1. 1.2
 - 2. 0.8
 - 3. 0.6
 - 4. 0.9

Question ID : 7079669347
Option 1 ID : 70796637386
Option 2 ID : 70796637385
Option 3 ID : 70796637387
Option 4 ID : 70796637388
Status : Not Answered
Chosen Option : --

Q.3
4 A car loses 200 kJ of kinetic energy when its speed decreases from 25 m/s to 15 m/s. Find its mass in tonnes.

- Ans
- 1. 2

2. 1.5
 3. 2.5
 4. 1

Question ID : 7079669318
Option 1 ID : 70796637269
Option 2 ID : 70796637270
Option 3 ID : 70796637271
Option 4 ID : 70796637272
Status : Not Answered
Chosen Option : --

Q.3 L is thrice as good a workman as M, and together, they finish a task in 12 days. In how many days will L alone finish
5 the same task?

- Ans 1. 16
 2. 32
 3. 48
 4. 40

Question ID : 7079669336
Option 1 ID : 70796637343
Option 2 ID : 70796637342
Option 3 ID : 70796637341
Option 4 ID : 70796637344
Status : Answered
Chosen Option : 2

Q.3 Pie chart 1 shows the share of the four partners (A, B, C and D) in Company XYZ in the year 2017. In 2018, a fifth
6 partner, E, was added by issuing 5000 shares to E (pie chart 2). The company has issued _____ shares more in
2018 than those in 2017.

- Ans 1. 33.33%
 2. 16.67%
 3. 20%
 4. 25%

Question ID : 7079669371
Option 1 ID : 70796637484
Option 2 ID : 70796637483
Option 3 ID : 70796637482
Option 4 ID : 70796637481
Status : Not Answered
Chosen Option : --

Q.3 The area of A0 size paper is _____.
7

- Ans 1. 10,000 cm²
 2. 1,000 cm²
 3. 1 cm²
 4. 100 cm²

Question ID : 7079669287

Option 1 ID : 70796637145
Option 2 ID : 70796637148
Option 3 ID : 70796637147
Option 4 ID : 70796637146
Status : Answered
Chosen Option : 2

Q.3 The _____ across the ends of a resistor is directly proportional to the current through it, provided its temperature remains the same.

- Ans
- 1. charge
 - 2. potential difference
 - 3. resistivity
 - 4. resistance

Question ID : 7079669309
Option 1 ID : 70796637236
Option 2 ID : 70796637235
Option 3 ID : 70796637234
Option 4 ID : 70796637233
Status : Answered
Chosen Option : 2

Q.3 A truck travels 450 km in two and a half hours. Find its speed in m/s.

- Ans
- 1. 60
 - 2. 50
 - 3. 90
 - 4. 75

Question ID : 7079669319
Option 1 ID : 70796637273
Option 2 ID : 70796637276
Option 3 ID : 70796637275
Option 4 ID : 70796637274
Status : Answered
Chosen Option : 3

Q.4 Which of the following is an example of a second class lever?

- Ans
- 1. Ice tongs
 - 2. See-saw
 - 3. Pliers
 - 4. Wheel barrow

Question ID : 7079669321
Option 1 ID : 70796637283
Option 2 ID : 70796637282
Option 3 ID : 70796637281
Option 4 ID : 70796637284
Status : Answered
Chosen Option : 4

Q.4
1 The specific latent heat of fusion of ethyl alcohol is 100 Jg^{-1} . Find the heat absorbed (in J) by 2.25 g of ethyl alcohol when it melts at its melting point of -114°C .

- Ans
- 1. 100
 - 2. 225
 - 3. 45
 - 4. 311

Question ID : 7079669288
Option 1 ID : 70796637152
Option 2 ID : 70796637151
Option 3 ID : 70796637149
Option 4 ID : 70796637150
Status : Not Answered
Chosen Option : --

Q.4
2 Find the slope of the line joining the points (3, -4) and (5, 2).

- Ans
- 1. 2
 - 2. $\frac{1}{2}$
 - 3. 3
 - 4. $\frac{1}{3}$

Question ID : 7079669344
Option 1 ID : 70796637373
Option 2 ID : 70796637376
Option 3 ID : 70796637375
Option 4 ID : 70796637374
Status : Not Answered
Chosen Option : --

Q.4
3 Binary number 101110110 is equal to decimal number _____.

- Ans
- 1. 468
 - 2. 374
 - 3. 412
 - 4. 326

Question ID : 7079669326
Option 1 ID : 70796637304
Option 2 ID : 70796637303
Option 3 ID : 70796637302
Option 4 ID : 70796637301
Status : Not Answered
Chosen Option : --

Q.4
4 A boy of 50 kg is riding a scooter of 100 kg mass at a speed of $v \text{ m/s}$. Find v (in m/s) if the kinetic energy of the scooter and the boy is 76.8 kJ.

- Ans
- 1. 80
 - 2. 32
 - 3. 40
 - 4. 64

Question ID : 7079669305
Option 1 ID : 70796637220
Option 2 ID : 70796637218
Option 3 ID : 70796637219
Option 4 ID : 70796637217
Status : Not Answered
Chosen Option : --

Q.4 Find the resistance of the wire (in $k\Omega$) through which a 5 mA current flows when 500 V of potential difference is applied across it.

- Ans
- 1. 2.5
 - 2. 100
 - 3. 1,00,000
 - 4. 2,500

Question ID : 7079669312
Option 1 ID : 70796637247
Option 2 ID : 70796637246
Option 3 ID : 70796637245
Option 4 ID : 70796637248
Status : Answered
Chosen Option : 3

Q.4 Find the least common multiple of 56 and 50.

- Ans
- 1. 1500
 - 2. 1400
 - 3. 800
 - 4. 700

Question ID : 7079669331
Option 1 ID : 70796637324
Option 2 ID : 70796637323
Option 3 ID : 70796637322
Option 4 ID : 70796637321
Status : Answered
Chosen Option : 2

Q.4 Select the option that is related to the third word on the same basis as the second word is related to the first word. Paper:

7 Glue:: Brick : ?

- Ans
- 1. Mason
 - 2. Wall
 - 3. Stone
 - 4. Mortar

Question ID : 7079669351
Option 1 ID : 70796637404
Option 2 ID : 70796637402
Option 3 ID : 70796637403
Option 4 ID : 70796637401
Status : Answered
Chosen Option : 4

Q.4 A _____ diagram is a schematic drawing that shows the relationships in a system, using simple shapes for the entities.

8

- Ans
- 1. block
 - 2. circuit
 - 3. Venn
 - 4. scatter

Question ID : 7079669299
Option 1 ID : 70796637195
Option 2 ID : 70796637196
Option 3 ID : 70796637194
Option 4 ID : 70796637193
Status : Answered
Chosen Option : 1

Q.4 _____ are a subset of air pollution that refers to the tiny particles suspended everywhere in our atmosphere.

9

- Ans
- 1. Humus
 - 2. Genomes
 - 3. Aerosols
 - 4. Loam

Question ID : 7079669324
Option 1 ID : 70796637295
Option 2 ID : 70796637294
Option 3 ID : 70796637293
Option 4 ID : 70796637296
Status : Answered
Chosen Option : 3

Q.5 A/An _____ is an interface on a computer to which you can connect a device.

0

- Ans
- 1. array
 - 2. anime
 - 3. port
 - 4. dongle

Question ID : 7079669325
Option 1 ID : 70796637298
Option 2 ID : 70796637297
Option 3 ID : 70796637299
Option 4 ID : 70796637300
Status : Answered
Chosen Option : 3

Q.5 Select the option that is related to the third word on the same basis as the second word is related to the first word. Pipe:

1 Cylinder:: Moon : ?

- Ans
- 1. Earth
 - 2. Night
 - 3. Sphere

 4. Stars

Question ID : 7079669352
Option 1 ID : 70796637405
Option 2 ID : 70796637407
Option 3 ID : 70796637406
Option 4 ID : 70796637408
Status : Answered
Chosen Option : 3

Q.5 Find the mechanical advantage of a pulley system if it has an efficiency of 60%. The load lifts by 3 m when the rope is
2 pulled by 12 m.

- Ans  1. 3.6
 2. 2.4
 3. 4.8
 4. 1.2

Question ID : 7079669313
Option 1 ID : 70796637249
Option 2 ID : 70796637252
Option 3 ID : 70796637251
Option 4 ID : 70796637250
Status : Not Answered
Chosen Option : --

Q.5 Choose the letter cluster that is different from the rest.
3

- Ans  1. MOQ
 2. EFG
 3. KLM
 4. RST

Question ID : 7079669366
Option 1 ID : 70796637464
Option 2 ID : 70796637462
Option 3 ID : 70796637461
Option 4 ID : 70796637463
Status : Answered
Chosen Option : 1

Q.5 If 1,200 J of work is done in pushing a trolley by 20 m, what was the force (in N) employed?
4

- Ans  1. 90
 2. 30
 3. 60
 4. 120

Question ID : 7079669292
Option 1 ID : 70796637167
Option 2 ID : 70796637168
Option 3 ID : 70796637166
Option 4 ID : 70796637165
Status : Answered

Chosen Option : 3

Q.5 Find the mass (in g) of a copper calorimeter if its temperature rises by 45° when it absorbs 3.6 kJ of heat. The specific heat capacity of copper is $0.4 \text{ Jg}^{-1}\text{K}^{-1}$.

- Ans
- 1. 500
 - 2. 405
 - 3. 200
 - 4. 648

Question ID : 7079669308
Option 1 ID : 70796637232
Option 2 ID : 70796637231
Option 3 ID : 70796637229
Option 4 ID : 70796637230
Status : Not Answered
Chosen Option : --

Q.5 Find the third proportional to 24 and 60.

- Ans
- 1. 164
 - 2. 150
 - 3. 120
 - 4. 144

Question ID : 7079669332
Option 1 ID : 70796637328
Option 2 ID : 70796637326
Option 3 ID : 70796637327
Option 4 ID : 70796637325
Status : Answered
Chosen Option : 2

Q.5 By cycling $\frac{7}{9}$ times his usual speed, Anwar reaches his school 4 minutes late. How many minutes does Anwar take to reach school at his usual cycling speed?

- Ans
- 1. 14
 - 2. 16
 - 3. 20
 - 4. 18

Question ID : 7079669315
Option 1 ID : 70796637258
Option 2 ID : 70796637257
Option 3 ID : 70796637260
Option 4 ID : 70796637259
Status : Not Answered
Chosen Option : --

Q.5 A pilgrim starts from her house to visit various places. She walks 13 km towards the east, then turns towards the north and walks 11 km, then turns towards the west and walks 7 km, then turns towards the south and walks 6 km and finally turns to her right and walks 6 km. Where is she now with respect to her starting position?

- Ans
- 1. 16 km south
 - 2. 5 km north

3. 16 km north

4. 5 km south

Question ID : 7079669368

Option 1 ID : 70796637471

Option 2 ID : 70796637472

Option 3 ID : 70796637470

Option 4 ID : 70796637469

Status : Not Answered

Chosen Option : --

Q.5 In an artificial language, 'terake' means 'motherland', 'lorake' means 'mother tongue' and 'loroli' means 'long tongue'.

9 Which word would mean 'long jump' in that language?

Ans 1. akezit

2. nemoli

3. dibnol

4. hudter

Question ID : 7079669356

Option 1 ID : 70796637424

Option 2 ID : 70796637421

Option 3 ID : 70796637422

Option 4 ID : 70796637423

Status : Answered

Chosen Option : 2

Q.6 If $5x/3 - 7/2 (2x/5 - 1/3) = 1/3$, then the value of x is _____.

Ans 1. $-25/8$

2. $5/14$

3. $-5/14$

4. $25/8$

Question ID : 7079669342

Option 1 ID : 70796637365

Option 2 ID : 70796637367

Option 3 ID : 70796637368

Option 4 ID : 70796637366

Status : Answered

Chosen Option : 2

Q.6 In an engineering drawing, which letters written on the dimension indicates that it is extra information and NOT really

1 required?

Ans 1. EXT

2. PER

3. NR

4. REF

Question ID : 7079669298

Option 1 ID : 70796637189

Option 2 ID : 70796637192

Option 3 ID : 70796637191

Option 4 ID : 70796637190
Status : Not Answered
Chosen Option : --

Q.6 Select the set of letters that when sequentially placed in the gaps of the given letter series will complete the series
2 logically.

a _yz_ bx_ zc_ cx_ z

- Ans
- 1. xybcy
 - 2. yxcbz
 - 3. xbycy
 - 4. xybcz

Question ID : 7079669353
Option 1 ID : 70796637409
Option 2 ID : 70796637411
Option 3 ID : 70796637412
Option 4 ID : 70796637410
Status : Not Answered
Chosen Option : --

Q.6 Acceleration due to gravity is highest at _____.
3

- Ans
- 1. the center of the earth
 - 2. the poles
 - 3. at an infinite distance from the earth
 - 4. the equator

Question ID : 7079669303
Option 1 ID : 70796637211
Option 2 ID : 70796637210
Option 3 ID : 70796637212
Option 4 ID : 70796637209
Status : Answered
Chosen Option : 2

Q.6 Choose the figure that is different from the rest.
4

Ans

1.

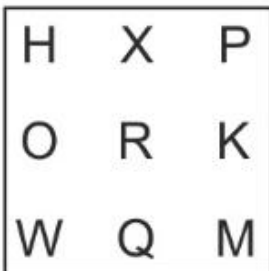

✓ 2.

K	W	Q
R	O	P
I	M	X

✗ 3.

P	O	R
M	W	K
H	X	Q

✗ 4.

Q	M	R
X	H	O
K	W	P

Question ID : 7079669365

Option 1 ID : 70796637459

Option 2 ID : 70796637458

Option 3 ID : 70796637460

Option 4 ID : 70796637457

Status : Not Answered

Chosen Option : --

Q.6 In the following figure, the triangle represents bakers, the square represents teachers, the circle represents Americans and the rectangle represents mothers. Which letter or set of letters represents the mothers who are neither Americans nor bakers?

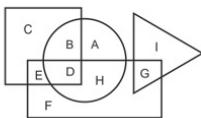

- Ans
- ✗ 1. I
 - ✗ 2. A
 - ✗ 3. C
 - ✓ 4. EF

Question ID : 7079669361

Option 1 ID : 70796637442

Option 2 ID : 70796637443

Option 3 ID : 70796637441

Option 4 ID : 70796637444

Status : Answered

Chosen Option : 4

Q.6
6 If the median of the numbers 9, 15, 1, 15, 14, 9, 4 and X is 11, find X.

- Ans
- 1. 10
 - 2. 13
 - 3. 12
 - 4. 11

Question ID : 7079669346
Option 1 ID : 70796637383
Option 2 ID : 70796637384
Option 3 ID : 70796637381
Option 4 ID : 70796637382
Status : Not Answered
Chosen Option : --

Q.6
7 The total surface area of a cuboid is 236 cm^2 . Its length is 8 cm and height is 6 cm. Find its breadth (in cm).

- Ans
- 1. 9
 - 2. 4
 - 3. 7
 - 4. 5

Question ID : 7079669335
Option 1 ID : 70796637338
Option 2 ID : 70796637339
Option 3 ID : 70796637337
Option 4 ID : 70796637340
Status : Not Answered
Chosen Option : --

Q.6
8 C said to D, "You are my sister's husband's mother-in-law." How is D related to C?

- Ans
- 1. D is the sister of C.
 - 2. D is the daughter of C.
 - 3. D is the mother of C.
 - 4. D is the mother-in-law of C.

Question ID : 7079669360
Option 1 ID : 70796637438
Option 2 ID : 70796637439
Option 3 ID : 70796637437
Option 4 ID : 70796637440
Status : Answered
Chosen Option : 3

Q.6
9 _____ is India's sole National Issuing & Guaranteeing Association for ATA Carnets (also known as 'Passport for Goods').

- Ans
- 1. All India Management Association
 - 2. Confederation of Indian Industry
 - 3. International Resources for Fairer Trade

✓ 4. Federation of Indian Chambers of Commerce & Industry

Question ID : 7079669278
Option 1 ID : 70796637111
Option 2 ID : 70796637109
Option 3 ID : 70796637110
Option 4 ID : 70796637112
Status : Not Answered
Chosen Option : --

Q.7
0 Two cabs A and B start from town C for town D. If the distance between the two towns is 540 km and the slower taxi travelling at an average speed of 90 km/hr takes an hour more than the faster taxi, then find the speed (in km/hr) of the faster taxi.

- Ans
- ✗ 1. 126
 - ✗ 2. 117
 - ✓ 3. 108
 - ✗ 4. 99

Question ID : 7079669306
Option 1 ID : 70796637224
Option 2 ID : 70796637222
Option 3 ID : 70796637223
Option 4 ID : 70796637221
Status : Not Answered
Chosen Option : --

Q.7
1 If $a^2 + b^2 = 53$ and $ab = 14$, then find the value of $a + b$.

- Ans
- ✗ 1. 15
 - ✓ 2. 9
 - ✗ 3. 5
 - ✗ 4. 12

Question ID : 7079669343
Option 1 ID : 70796637369
Option 2 ID : 70796637370
Option 3 ID : 70796637371
Option 4 ID : 70796637372
Status : Answered
Chosen Option : 2

Q.7
2 Which of the following classes of chemicals can damage the ozone layer?

- Ans
- ✗ 1. Phenols
 - ✗ 2. Antimicrobials
 - ✗ 3. Aromatic compounds
 - ✓ 4. Chlorofluorocarbons

Question ID : 7079669323
Option 1 ID : 70796637291
Option 2 ID : 70796637290
Option 3 ID : 70796637289

Option 4 ID : 70796637292
Status : Answered
Chosen Option : 4

Q.7 Acceleration due to gravity on Jupiter is two and a half times that on earth. How much would a 250 kg satellite weigh
3 (in N) on Jupiter? (acceleration due to gravity on earth = 10m/s^2)

- Ans
- 1. 625
 - 2. 6,250
 - 3. 100
 - 4. 10

Question ID : 7079669296
Option 1 ID : 70796637182
Option 2 ID : 70796637183
Option 3 ID : 70796637181
Option 4 ID : 70796637184
Status : Answered
Chosen Option : 3

Q.7 Which of the following is NOT a derived unit?
4

- Ans
- 1. Volt
 - 2. Mole
 - 3. Radian
 - 4. Lumen

Question ID : 7079669301
Option 1 ID : 70796637203
Option 2 ID : 70796637204
Option 3 ID : 70796637201
Option 4 ID : 70796637202
Status : Answered
Chosen Option : 2

Q.7 Henry per meter is the unit of _____.
5

- Ans
- 1. permittivity
 - 2. permeability
 - 3. watt per steradian
 - 4. electric conductance

Question ID : 7079669302
Option 1 ID : 70796637205
Option 2 ID : 70796637208
Option 3 ID : 70796637207
Option 4 ID : 70796637206
Status : Answered
Chosen Option : 1

Q.7 If $\sin\theta = 12/13$, then find the value of $2\cot\theta + 13\cos\theta$.
6

Ans

- ✓ 1. 35/6
- ✗ 2. 25/6
- ✗ 3. 5/8
- ✗ 4. 15/8

Question ID : 7079669345
Option 1 ID : 70796637379
Option 2 ID : 70796637377
Option 3 ID : 70796637380
Option 4 ID : 70796637378
Status : Answered
Chosen Option : 1

Q.7 A vendor buys a certain number of bananas at 8 pieces for `5 and sells them at 5 pieces for `8. What will be his percentage profit?

- Ans
- ✗ 1. 144%
 - ✓ 2. 156%
 - ✗ 3. 40%
 - ✗ 4. 48%

Question ID : 7079669341
Option 1 ID : 70796637363
Option 2 ID : 70796637362
Option 3 ID : 70796637361
Option 4 ID : 70796637364
Status : Answered
Chosen Option : 2

Q.7 The notation $2 \times O6$ means _____.

- Ans
- ✗ 1. Scale the circle of radius 6 units by a factor of 2
 - ✗ 2. 2 circles of radius 6 units
 - ✗ 3. Scale the circle of diameter 6 units by a factor of 2
 - ✓ 4. 2 circles of diameter 6 units

Question ID : 7079669290
Option 1 ID : 70796637160
Option 2 ID : 70796637157
Option 3 ID : 70796637159
Option 4 ID : 70796637158
Status : Not Answered
Chosen Option : --

Q.7 Moore's Law is a rule of thumb stated by Intel co-founder Gordon Moore that the number of transistors on a chip doubles every _____ months.

- Ans
- ✗ 1. 30
 - ✗ 2. 12
 - ✗ 3. 24
 - ✓ 4. 18

Question ID : 7079669295
Option 1 ID : 70796637180
Option 2 ID : 70796637178
Option 3 ID : 70796637179
Option 4 ID : 70796637177
Status : Answered
Chosen Option : 4

Q.8 Find the missing number in the given series.

-2.7, -2.1, -1.5, -0.9, -0.3, ?

- Ans 1. 0.3
 2. 0.2
 3. 0.5
 4. 0.4

Question ID : 7079669354
Option 1 ID : 70796637416
Option 2 ID : 70796637415
Option 3 ID : 70796637414
Option 4 ID : 70796637413
Status : Answered
Chosen Option : 1

Q.8 The Directive Principles of State Policy in India's Constitution are borrowed from the constitution of _____.

- 1
Ans 1. Canada
 2. Ireland
 3. Germany
 4. Britain

Question ID : 7079669276
Option 1 ID : 70796637102
Option 2 ID : 70796637104
Option 3 ID : 70796637103
Option 4 ID : 70796637101
Status : Not Answered
Chosen Option : --

Q.8 From a 50-m-long steel bar, a workman has to cut off as many 5.25-m-long pieces as possible. What decimal fraction of the whole will be left?

- 2
Ans 1. 0.035
 2. 0.045
 3. 0.025
 4. 0.055

Question ID : 7079669329
Option 1 ID : 70796637316
Option 2 ID : 70796637315
Option 3 ID : 70796637314
Option 4 ID : 70796637313
Status : Not Answered

Chosen Option : --

Q.8
3 Who was the captain of the IPL team Chennai Super Kings, in 2018?

- Ans
- 1. Mahendra Singh Dhoni
 - 2. Virat Kohli
 - 3. Gautam Gambhir
 - 4. Rohit Sharma

Question ID : 7079669282
Option 1 ID : 70796637126
Option 2 ID : 70796637125
Option 3 ID : 70796637127
Option 4 ID : 70796637128
Status : Answered
Chosen Option : 1

Q.8
4 Which Dadasaheb Phalke Award recipient produced and directed India's first colour film, 'Sairandhri'?

- Ans
- 1. Birendranath Sirdar
 - 2. Sivaji Ganesan
 - 3. LV Prasad
 - 4. V Shanta ram

Question ID : 7079669279
Option 1 ID : 70796637115
Option 2 ID : 70796637116
Option 3 ID : 70796637114
Option 4 ID : 70796637113
Status : Not Answered
Chosen Option : --

Q.8
5 If $14 \# 2 = 80$, $10 \# 4 = 70$ and $20 \# 6 = 130$, then find the value of $8 \# 12$.

- Ans
- 1. 2
 - 2. 100
 - 3. 10
 - 4. 4

Question ID : 7079669358
Option 1 ID : 70796637430
Option 2 ID : 70796637432
Option 3 ID : 70796637431
Option 4 ID : 70796637429
Status : Not Answered
Chosen Option : --

Q.8
6 A train running at a speed of 64 km/h takes 50 min to travel a certain distance. By how much should it increase its speed (in km/h) to travel the same distance in 40 min?

- Ans
- 1. 25
 - 2. 16

3. 10
 4. 80

Question ID : 7079669338
Option 1 ID : 70796637352
Option 2 ID : 70796637349
Option 3 ID : 70796637351
Option 4 ID : 70796637350
Status : Not Answered
Chosen Option : --

Q.8 If the compound interest received on a certain amount in the first year is ₹1,440, what will be the compound interest for
7 the second year on the same principal at a 10% rate of interest?

- Ans 1. ₹1,540
 2. ₹1,512
 3. ₹1,554
 4. ₹1,584

Question ID : 7079669339
Option 1 ID : 70796637355
Option 2 ID : 70796637356
Option 3 ID : 70796637353
Option 4 ID : 70796637354
Status : Not Answered
Chosen Option : --

Q.8 A uniform meter scale weighs 50g. It is pivoted at the 70cm mark. Where should a 40 g mass be placed so that the scale
8 is in equilibrium?

- Ans 1. At the 25 cm mark
 2. At the 45 cm mark
 3. At the 5 cm mark
 4. At the 95 cm mark

Question ID : 7079669297
Option 1 ID : 70796637187
Option 2 ID : 70796637185
Option 3 ID : 70796637186
Option 4 ID : 70796637188
Status : Not Answered
Chosen Option : --

Q.8 Two resistors of $R \Omega$ and 15Ω are connected in parallel to get an effective resistance of 12Ω . Find R .
9

- Ans 1. 75
 2. 30
 3. 60
 4. 45

Question ID : 7079669310
Option 1 ID : 70796637240
Option 2 ID : 70796637237

Option 3 ID : 70796637239
Option 4 ID : 70796637238
Status : Answered
Chosen Option : 3

Q.9
0 Classical musician Vilayat Khan is associated with which musical instrument?

- Ans
- 1. Sarod
 - 2. Santoor
 - 3. Flute
 - 4. Sitar

Question ID : 7079669284
Option 1 ID : 70796637133
Option 2 ID : 70796637134
Option 3 ID : 70796637136
Option 4 ID : 70796637135
Status : Not Answered
Chosen Option : --

Q.9
1 _____ ° Celsius = 167 Fahrenheit

- Ans
- 1. 103
 - 2. 75
 - 3. 348
 - 4. 198

Question ID : 7079669320
Option 1 ID : 70796637278
Option 2 ID : 70796637277
Option 3 ID : 70796637279
Option 4 ID : 70796637280
Status : Answered
Chosen Option : 2

Q.9
2 In this question, two statements are given, followed by two conclusions labelled I and II. You have to consider the statements to be true even if they seem to be at variance with commonly known facts, and decide which of the given conclusions, if any, follow(s) from the given statements.

Statements:

No beakers are vases.
All vases are jugs.

Conclusions:

I: Some jugs are beakers.
II: Some jugs are vases.

- Ans
- 1. Both conclusions I and II follow.
 - 2. Only conclusion I follows.
 - 3. Only conclusion II follows.
 - 4. Neither conclusion I nor II follows.

Question ID : 7079669363

Option 1 ID : 70796637451

Option 2 ID : 70796637449

Option 3 ID : 70796637450

Option 4 ID : 70796637452

Status : Answered

Chosen Option : 3

Q.9 If '+' represents 'x', '÷' represents '+', '-' represents '÷' and 'x' represents '-', then find the value of the following expression.

3

$$8 + 4 \div 15 - 3 \times 1$$

Ans 1. 17

2. 36

3. 10

4. 14

Question ID : 7079669357

Option 1 ID : 70796637427

Option 2 ID : 70796637428

Option 3 ID : 70796637425

Option 4 ID : 70796637426

Status : Answered

Chosen Option : 2

Q.9 Henry Cavendish discovered _____ in 1766.

4

Ans 1. helium

2. hydrogen

3. chlorine

4. oxygen

Question ID : 7079669280

Option 1 ID : 70796637119

Option 2 ID : 70796637118

Option 3 ID : 70796637117

Option 4 ID : 70796637120

Status : Not Answered

Chosen Option : --

Q.9 The weights of three boxes are 3 kg, 8 kg and 12 kg. Which of the following CANNOT be the total weight, in kg, of any combination of these boxes?

5

Ans 1. 15

2. 21

3. 23

4. 20

Question ID : 7079669374

Option 1 ID : 70796637493

Option 2 ID : 70796637495

Option 3 ID : 70796637496

Option 4 ID : 70796637494

Status : Answered

Chosen Option : 3

Q.9 The given Venn diagram shows the pet(s) that each house in a society has. How many houses have only two pets?
6

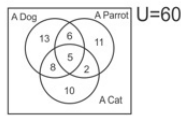

- Ans
- 1. 15
 - 2. 21
 - 3. 5
 - 4. 16

Question ID : 7079669362
Option 1 ID : 70796637448
Option 2 ID : 70796637447
Option 3 ID : 70796637445
Option 4 ID : 70796637446
Status : Not Answered
Chosen Option : --

Q.9 Name the celebrity who has authored 'Mrs. Funnybones'?
7

- Ans
- 1. Twinkle Khanna
 - 2. Bipasha Basu
 - 3. Shraddha Kapoor
 - 4. Sonakshi Sinha

Question ID : 7079669281
Option 1 ID : 70796637122
Option 2 ID : 70796637121
Option 3 ID : 70796637123
Option 4 ID : 70796637124
Status : Answered
Chosen Option : 1

Q.9 A block of metal of mass 500 g has a relative density of 2.5. What will be its apparent mass when it is fully immersed in water?
8

- Ans
- 1. 250 g
 - 2. 200 g
 - 3. 300 g
 - 4. 400 g

Question ID : 7079669314
Option 1 ID : 70796637255
Option 2 ID : 70796637254
Option 3 ID : 70796637253
Option 4 ID : 70796637256
Status : Not Answered
Chosen Option : --

Q.9 Find the density (in kg/m^3) of a piece of wood of dimensions $6 \text{ cm} \times 8 \text{ cm} \times 5 \text{ cm}$, and weight 1.92 N. (Use $g=10\text{m/s}^2$)
9

- Ans
- 1. 800

2. 8,000

3. 300

4. 3,000

Question ID : 7079669304

Option 1 ID : 70796637216

Option 2 ID : 70796637213

Option 3 ID : 70796637215

Option 4 ID : 70796637214

Status : **Not Answered**

Chosen Option : --

Q.1 Part of a sentence has been divided into three segments, which are jumbled up and given along with the unjumbled part.

00 Rearrange the parts of the sentence in correct order.

I'd just remembered that our

X: every once in a while, so our changing

Y: rooms were movable, on wheels

Z: owner liked to change the decor of the boutique

Ans 1. ZXY

2. XZY

3. ZYX

4. YXZ

Question ID : 7079669372

Option 1 ID : 70796637488

Option 2 ID : 70796637486

Option 3 ID : 70796637485

Option 4 ID : 70796637487

Status : **Answered**

Chosen Option : 1

Section : Electronics Mechanic

Q.1 What is the internal general purpose memory of 8051 micro controller?

Ans 1. 16 Byte

2. 128 Byte

3. 8 Byte

4. 64 Byte

Question ID : 7079669441

Option 1 ID : 70796637762

Option 2 ID : 70796637764

Option 3 ID : 70796637761

Option 4 ID : 70796637763

Status : **Not Answered**

Chosen Option : --

Q.2 In an amplifier with a negative feedback circuit, gain A_f is given by:

Ans

1. $A_f = (1 + A_m)/A$

2. $A_f = (1 - A_m)/A$

3. $A_f = A/(1 - A_m)$

4. $A_f = A/(1 + A_m)$

Question ID : 7079669398

Option 1 ID : 70796637591

Option 2 ID : 70796637592

Option 3 ID : 70796637590

Option 4 ID : 70796637589

Status : Answered

Chosen Option : 4

Q.3 The full form of LED is:

Ans 1. Light Emitting Diode

2. Lowlight Erecting Diode

3. Light Editing Diode

4. Light Erecting Diode

Question ID : 7079669407

Option 1 ID : 70796637625

Option 2 ID : 70796637628

Option 3 ID : 70796637626

Option 4 ID : 70796637627

Status : Answered

Chosen Option : 1

Q.4 An optical fiber is a cylindrical dielectric waveguide that transmits _____ along its axis.

Ans 1. ultra violet rays

2. light

3. X rays

4. gama rays

Question ID : 7079669426

Option 1 ID : 70796637704

Option 2 ID : 70796637703

Option 3 ID : 70796637701

Option 4 ID : 70796637702

Status : Answered

Chosen Option : 2

Q.5 Which among the following is used as receiver in fiber optic communication?

Ans 1. LDR

2. LED

3. Photo Transistor

4. LASER Diode

Question ID : 7079669416
Option 1 ID : 70796637664
Option 2 ID : 70796637661
Option 3 ID : 70796637663
Option 4 ID : 70796637662
Status : Answered
Chosen Option : 1

Q.6 DA converter is a part of:

- Ans
- 1. odometer
 - 2. analog meter
 - 3. panel board meter
 - 4. proximity sensor

Question ID : 7079669410
Option 1 ID : 70796637640
Option 2 ID : 70796637638
Option 3 ID : 70796637639
Option 4 ID : 70796637637
Status : Not Answered
Chosen Option : --

Q.7 Mobile phones/cell phones consist of a small _____ and _____.

- Ans
- 1. transmitter; microphone
 - 2. walky; talky
 - 3. transmitter; receiver
 - 4. transmitter; speaker

Question ID : 7079669433
Option 1 ID : 70796637731
Option 2 ID : 70796637730
Option 3 ID : 70796637732
Option 4 ID : 70796637729
Status : Answered
Chosen Option : 3

Q.8 Which one of the following is a photo-voltaic module?

- Ans
- 1. Zener modules
 - 2. Rectifier modules
 - 3. Transistor modules
 - 4. Solar modules

Question ID : 7079669432
Option 1 ID : 70796637726
Option 2 ID : 70796637727
Option 3 ID : 70796637728
Option 4 ID : 70796637725
Status : Not Answered
Chosen Option : --

Q.9 Convert decimal 32 to hexadecimal.

- Ans
- 1. 20
 - 2. 30
 - 3. 10
 - 4. 40

Question ID : 7079669450
Option 1 ID : 70796637798
Option 2 ID : 70796637799
Option 3 ID : 70796637797
Option 4 ID : 70796637800
Status : Not Answered
Chosen Option : --

Q.1 _____ is the Input voltage Specification of a UPS. Choose from the given option

- Ans
- 1. 208V/120 V and 50/60 Hz
 - 2. Regulation + or - 3%
 - 3. 20 μ F
 - 4. 100 A

Question ID : 7079669431
Option 1 ID : 70796637721
Option 2 ID : 70796637722
Option 3 ID : 70796637724
Option 4 ID : 70796637723
Status : Answered
Chosen Option : 1

Q.1 Which type of feedback is used in case of an oscillator circuit?

- Ans
- 1. Zero
 - 2. Positive
 - 3. Negative
 - 4. Unity

Question ID : 7079669443
Option 1 ID : 70796637772
Option 2 ID : 70796637769
Option 3 ID : 70796637770
Option 4 ID : 70796637771
Status : Answered
Chosen Option : 2

Q.1 If an amplifier circuit has negative feedback, then gain:

- Ans
- 1. increases and decreases
 - 2. stays constant
 - 3. increases

✓ 4. decrease

Question ID : 7079669399
Option 1 ID : 70796637596
Option 2 ID : 70796637595
Option 3 ID : 70796637593
Option 4 ID : 70796637594
Status : Answered
Chosen Option : 4

Q.1
3 Which of the following is a cell phone component?

- Ans
- ✗ 1. SPTS
 - ✗ 2. Relay
 - ✓ 3. An Antenna
 - ✗ 4. DPDS

Question ID : 7079669434
Option 1 ID : 70796637733
Option 2 ID : 70796637735
Option 3 ID : 70796637734
Option 4 ID : 70796637736
Status : Answered
Chosen Option : 3

Q.1
4 Which of the following computer hardware contains a laser?

- Ans
- ✗ 1. RAM
 - ✓ 2. CD Drive
 - ✗ 3. Hard Disk Drive
 - ✗ 4. Floppy Drive

Question ID : 7079669389
Option 1 ID : 70796637556
Option 2 ID : 70796637555
Option 3 ID : 70796637554
Option 4 ID : 70796637553
Status : Answered
Chosen Option : 4

Q.1
5 In the path given below, what is the voltage across R1 resistor?

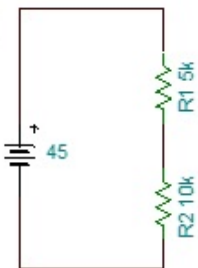

- Ans
- ✗ 1. 20
 - ✗ 2. 10

- ✓ 3. 15
- ✗ 4. 30

Question ID : 7079669378
Option 1 ID : 70796637510
Option 2 ID : 70796637509
Option 3 ID : 70796637511
Option 4 ID : 70796637512
Status : Answered
Chosen Option : 3

Q.1
6 Additional heat is dissipated from power transistor by using

- Ans
- ✗ 1. mica sheet and heat sink
 - ✗ 2. silicon paste.
 - ✗ 3. mica sheet
 - ✓ 4. heat sink

Question ID : 7079669396
Option 1 ID : 70796637583
Option 2 ID : 70796637584
Option 3 ID : 70796637581
Option 4 ID : 70796637582
Status : Answered
Chosen Option : 4

Q.1
7 Which of the following has superior bandwidth and temperature stability?

- Ans
- ✗ 1. PNP diode
 - ✓ 2. Photo diode
 - ✗ 3. Zener diode
 - ✗ 4. PN diode

Question ID : 7079669412
Option 1 ID : 70796637648
Option 2 ID : 70796637647
Option 3 ID : 70796637646
Option 4 ID : 70796637645
Status : Not Answered
Chosen Option : --

Q.1
8 What are the XTAL 1 and XTAL 2 pins numbers for 8051?

- Ans
- ✗ 1. 15 and 16
 - ✓ 2. 18 and 19
 - ✗ 3. 12 and 13
 - ✗ 4. 17 and 18

Question ID : 7079669422
Option 1 ID : 70796637685
Option 2 ID : 70796637686
Option 3 ID : 70796637688

Option 4 ID : 70796637687
Status : Answered
Chosen Option : 3

Q.1
9 Which of the following software is used for electronic circuit simulation?

- Ans
- 1. P Spice
 - 2. Photoshop
 - 3. Firefox
 - 4. Windows 10

Question ID : 7079669388
Option 1 ID : 70796637549
Option 2 ID : 70796637550
Option 3 ID : 70796637552
Option 4 ID : 70796637551
Status : Answered
Chosen Option : 1

Q.2
0 After crossing the peak point, UJT resistance becomes _____.

- Ans
- 1. Low
 - 2. Infinite
 - 3. Zero
 - 4. Negative

Question ID : 7079669449
Option 1 ID : 70796637794
Option 2 ID : 70796637793
Option 3 ID : 70796637795
Option 4 ID : 70796637796
Status : Not Answered
Chosen Option : --

Q.2
1 Which of the following losses can be observed in a transformer when it is NOT connected to any load?

- Ans
- 1. Copper Loss
 - 2. Core Loss
 - 3. Thermal Loss
 - 4. Voltage Loss

Question ID : 7079669383
Option 1 ID : 70796637529
Option 2 ID : 70796637530
Option 3 ID : 70796637531
Option 4 ID : 70796637532
Status : Answered
Chosen Option : 1

Q.2
2 BC147 is the transistor used for:

Ans

- 1. RF power amplifier
- 2. amplification of AF and RF signal
- 3. amplification of AF signal
- 4. amplification of RF signal

Question ID : 7079669395
Option 1 ID : 70796637580
Option 2 ID : 70796637579
Option 3 ID : 70796637578
Option 4 ID : 70796637577
Status : Not Answered
Chosen Option : --

Q.2
3 Which of the following is a feature of SMPS?

- Ans
- 1. High efficiency
 - 2. AF gain
 - 3. Power buck
 - 4. RF gain

Question ID : 7079669415
Option 1 ID : 70796637657
Option 2 ID : 70796637658
Option 3 ID : 70796637660
Option 4 ID : 70796637659
Status : Answered
Chosen Option : 3

Q.2
4 What is the operating point of a transistor as an amplifier known as?

- Ans
- 1. Quiescent Point
 - 2. Cutoff Point
 - 3. Saturation Point
 - 4. Flood In Point

Question ID : 7079669442
Option 1 ID : 70796637768
Option 2 ID : 70796637767
Option 3 ID : 70796637765
Option 4 ID : 70796637766
Status : Answered
Chosen Option : 1

Q.2
5 What is the function of the discharge transistor in a 555 timer circuit?

- Ans
- 1. To start the timing by charging the external capacitor
 - 2. To stop the timing by charging the external capacitor
 - 3. To stop the timing by discharging the external capacitor

✔ 4. To start the timing by discharging the external capacitor

Question ID : 7079669445
Option 1 ID : 70796637779
Option 2 ID : 70796637777
Option 3 ID : 70796637780
Option 4 ID : 70796637778
Status : Answered
Chosen Option : 3

Q.2
6 For Clipping of input AC signal a _____ is used.

- Ans
- ✔ 1. Diode
 - ✘ 2. FET
 - ✘ 3. Transistor
 - ✘ 4. Triode

Question ID : 7079669402
Option 1 ID : 70796637606
Option 2 ID : 70796637608
Option 3 ID : 70796637605
Option 4 ID : 70796637607
Status : Answered
Chosen Option : 1

Q.2
7 UJT has:

- Ans
- ✔ 1. negative characteristics
 - ✘ 2. no positive or negative characteristics
 - ✘ 3. positive characteristics
 - ✘ 4. both positive and negative characteristics

Question ID : 7079669404
Option 1 ID : 70796637614
Option 2 ID : 70796637616
Option 3 ID : 70796637613
Option 4 ID : 70796637615
Status : Answered
Chosen Option : 4

Q.2
8 NPN Transistor proper biasing for conduction is

- Ans
- ✔ 1. base, emitter forward bias and collector , emitter reverse bias
 - ✘ 2. base, emitter forward bias and collector, emitter forward bias
 - ✘ 3. base, emitter reverse bias and collector, emitter forward bias
 - ✘ 4. base direct and collector direct

Question ID : 7079669393
Option 1 ID : 70796637570
Option 2 ID : 70796637571
Option 3 ID : 70796637569
Option 4 ID : 70796637572
Status : Answered
Chosen Option : 1

Q.2
9 Beta is the ratio of:

- Ans
- 1. base current to collector current
 - 2. collector current to emitter current
 - 3. emitter to collector
 - 4. collector current to base current

Question ID : 7079669392
Option 1 ID : 70796637567
Option 2 ID : 70796637566
Option 3 ID : 70796637568
Option 4 ID : 70796637565
Status : Answered
Chosen Option : 4

Q.3
0 Select the correct UPS output specifications.

- Ans
- 1. Regulation + or - 3%
 - 2. 40 W
 - 3. 20 μ F
 - 4. 100 A

Question ID : 7079669417
Option 1 ID : 70796637666
Option 2 ID : 70796637665
Option 3 ID : 70796637668
Option 4 ID : 70796637667
Status : Answered
Chosen Option : 2

Q.3
1 Pulses of Light are used in _____ for communication system to transmit information.

- Ans
- 1. FM Transmitter
 - 2. AM Transmitter
 - 3. Digital Transmitter
 - 4. Fiber Optic Transmitter

Question ID : 7079669411
Option 1 ID : 70796637642
Option 2 ID : 70796637641
Option 3 ID : 70796637643
Option 4 ID : 70796637644
Status : Answered
Chosen Option : 4

Q.3 TV channel frequencies are assigned in the 54 to 806 MHz range for the division of _____ TV channels.

2

- Ans
- 1. 76
 - 2. 86
 - 3. 68
 - 4. 78

Question ID : 7079669439
Option 1 ID : 70796637756
Option 2 ID : 70796637753
Option 3 ID : 70796637754
Option 4 ID : 70796637755
Status : Not Answered
Chosen Option : --

Q.3 In which of the following transistor configuration is the amplifier voltage gain the lowest?

3

- Ans
- 1. Emitter Coupled
 - 2. Common Collector
 - 3. Common Base
 - 4. Common Emitter

Question ID : 7079669448
Option 1 ID : 70796637791
Option 2 ID : 70796637792
Option 3 ID : 70796637790
Option 4 ID : 70796637789
Status : Answered
Chosen Option : 4

Q.3 In two stage RC coupling, the function of a C_c capacitor is to:

4

- Ans
- 1. pass AC and DC
 - 2. block AC and DC
 - 3. block the AC i/p
 - 4. block the DC Voltage

Question ID : 7079669397
Option 1 ID : 70796637588
Option 2 ID : 70796637587
Option 3 ID : 70796637585
Option 4 ID : 70796637586
Status : Not Answered
Chosen Option : --

Q.3 Select the communication device which works on Full Duplex Communication Channel.

5

- Ans
- 1. Telegraph
 - 2. Mobile
 - 3. Walky talky

4. TV

Question ID : 7079669419
Option 1 ID : 70796637673
Option 2 ID : 70796637675
Option 3 ID : 70796637674
Option 4 ID : 70796637676
Status : Answered
Chosen Option : 2

Q.3
6 The Size of internal RAM of 8051 Microcontroller is?

- Ans 1. 128 Bytes
 2. 256 Bytes
 3. 16 Bytes
 4. 64 Bytes

Question ID : 7079669379
Option 1 ID : 70796637514
Option 2 ID : 70796637516
Option 3 ID : 70796637513
Option 4 ID : 70796637515
Status : Answered
Chosen Option : 3

Q.3
7 Which among the following laws is shown in the given figure?

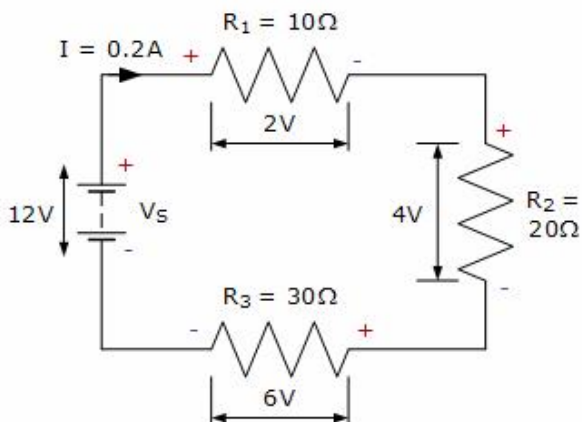

- Ans 1. KVL
 2. Ohm's Law
 3. KCL
 4. Faraday's Law

Question ID : 7079669385
Option 1 ID : 70796637538
Option 2 ID : 70796637537
Option 3 ID : 70796637539
Option 4 ID : 70796637540
Status : Answered

Chosen Option : 1

Q.3
8 What is the type of transformer used in home inverters to power from a 12V battery?

- Ans
- 1. Step-up
 - 2. One to one
 - 3. Star to delta
 - 4. Step-down

Question ID : 7079669384
Option 1 ID : 70796637535
Option 2 ID : 70796637533
Option 3 ID : 70796637534
Option 4 ID : 70796637536
Status : Answered
Chosen Option : 1

Q.3
9 Side by side stack drivers are mounted on:

- Ans
- 1. SMPS
 - 2. LED Drivers
 - 3. Low Power Supply
 - 4. UPS

Question ID : 7079669436
Option 1 ID : 70796637741
Option 2 ID : 70796637743
Option 3 ID : 70796637744
Option 4 ID : 70796637742
Status : Not Answered
Chosen Option : --

Q.4
0 Which among the following Electronic component works with the principle of Light to Voltage conversion?

- Ans
- 1. Bridge rectifier
 - 2. Zener diode
 - 3. Half-wave rectifier
 - 4. Solar cells

Question ID : 7079669418
Option 1 ID : 70796637671
Option 2 ID : 70796637670
Option 3 ID : 70796637672
Option 4 ID : 70796637669
Status : Answered
Chosen Option : 4

Q.4
1 What is the use of 'Ctrl + r' key in Microsoft Word

- Ans
- 1. Move the cursor to the bottom of a page
 - 2. Move the cursor to the left of a page

- 3. Move the cursor to the middle of a page
- 4. Move the cursor to the right of a page

Question ID : 7079669390
Option 1 ID : 70796637559
Option 2 ID : 70796637558
Option 3 ID : 70796637560
Option 4 ID : 70796637557
Status : Answered
Chosen Option : 4

Q.4
2 Which of the following is a type of UPS?

- Ans
- 1. Line interactive
 - 2. By-stand by UPS
 - 3. Un-stand by UPS types
 - 4. Uni-stand by UPS types

Question ID : 7079669430
Option 1 ID : 70796637717
Option 2 ID : 70796637720
Option 3 ID : 70796637718
Option 4 ID : 70796637719
Status : Answered
Chosen Option : 1

Q.4
3 As the colour varies, forward voltage varies, in:

- Ans
- 1. LED
 - 2. LCD TV
 - 3. Colour TV
 - 4. LED TV

Question ID : 7079669421
Option 1 ID : 70796637684
Option 2 ID : 70796637683
Option 3 ID : 70796637681
Option 4 ID : 70796637682
Status : Not Answered
Chosen Option : --

Q.4
4 Which of the following is a sensor that is able to detect objects without any physical contact?

- Ans
- 1. Electron beam
 - 2. Laser beam
 - 3. Proximity sensor
 - 4. X ray

Question ID : 7079669424
Option 1 ID : 70796637696

Option 2 ID : 70796637694
Option 3 ID : 70796637693
Option 4 ID : 70796637695
Status : Answered
Chosen Option : 3

Q.4
5 Which of the given cores of an inductor will have the highest inductance?

- Ans 1. Iron
 2. Copper
 3. Wood
 4. Air

Question ID : 7079669380
Option 1 ID : 70796637517
Option 2 ID : 70796637518
Option 3 ID : 70796637519
Option 4 ID : 70796637520
Status : Answered
Chosen Option : 2

Q.4
6 Which force is responsible for the flow of electron from point A to B through a conductor?

- Ans 1. Heat
 2. Current
 3. Voltage
 4. Resistance

Question ID : 7079669376
Option 1 ID : 70796637501
Option 2 ID : 70796637502
Option 3 ID : 70796637503
Option 4 ID : 70796637504
Status : Answered
Chosen Option : 3

Q.4
7 Which among the following devices is a P-N junction diode with 3 terminals, as per construction

- Ans 1. BJT
 2. FET
 3. UJT
 4. SCR

Question ID : 7079669446
Option 1 ID : 70796637783
Option 2 ID : 70796637784
Option 3 ID : 70796637782
Option 4 ID : 70796637781
Status : Answered
Chosen Option : 1

Q.4
8 Which of the following gates gives output 1 when any one of the input is 1?

- Ans 1. OR
 2. NOT
 3. NOR
 4. AND

Question ID : 7079669413
Option 1 ID : 70796637651
Option 2 ID : 70796637650
Option 3 ID : 70796637649
Option 4 ID : 70796637652
Status : Answered
Chosen Option : 1

Q.4 In which type of counter is the last stage of shift register fed back to D of first stage?

- Ans 1. Ring
 2. Round
 3. Johnson
 4. Strait

Question ID : 7079669444
Option 1 ID : 70796637774
Option 2 ID : 70796637773
Option 3 ID : 70796637775
Option 4 ID : 70796637776
Status : Not Answered
Chosen Option : --

Q.5 What is the decimal value for HEX 2A

- Ans 1. 22
 2. 42
 3. 32
 4. 12

Question ID : 7079669447
Option 1 ID : 70796637786
Option 2 ID : 70796637788
Option 3 ID : 70796637787
Option 4 ID : 70796637785
Status : Not Answered
Chosen Option : --

Q.5 The output of SMPS is _____.

- Ans 1. pulsating DC
 2. voltage sweep
 3. AC
 4. DC

Question ID : 7079669440

Option 1 ID : 70796637759
Option 2 ID : 70796637757
Option 3 ID : 70796637760
Option 4 ID : 70796637758
Status : Answered
Chosen Option : 2

Q.5
2 The input impedance of an ideal Op-amp is _____.

- Ans
- 1. 100 Ω
 - 2. Infinite
 - 3. Unity
 - 4. Zero

Question ID : 7079669420
Option 1 ID : 70796637680
Option 2 ID : 70796637679
Option 3 ID : 70796637678
Option 4 ID : 70796637677
Status : Answered
Chosen Option : 2

Q.5
3 A PN junction diode that _____ when activated is called a/an _____.

- Ans
- 1. emits photons; LCD
 - 2. emits electrons; diode
 - 3. emits electrons; regulator
 - 4. emits light; LED

Question ID : 7079669435
Option 1 ID : 70796637739
Option 2 ID : 70796637737
Option 3 ID : 70796637738
Option 4 ID : 70796637740
Status : Answered
Chosen Option : 4

Q.5
4 Hue and saturation are said to collectively describe the:

- Ans
- 1. chromaticity of TV
 - 2. brightness of TV
 - 3. luminance of TV
 - 4. AGC of TV

Question ID : 7079669438
Option 1 ID : 70796637750
Option 2 ID : 70796637751
Option 3 ID : 70796637749
Option 4 ID : 70796637752
Status : Answered
Chosen Option : 1

Q.5
5 12 V DC and 24 V DC are general operating voltages for:

- Ans
- 1. multi meter
 - 2. analog and digital panel meter
 - 3. industrial lighting
 - 4. domestic lighting

Question ID : 7079669427
Option 1 ID : 70796637708
Option 2 ID : 70796637707
Option 3 ID : 70796637706
Option 4 ID : 70796637705
Status : Answered
Chosen Option : 1

Q.5
6 Which of the following is a part of SMPS component?

- Ans
- 1. Output filter coil
 - 2. MOSFET
 - 3. Zener diode
 - 4. FET

Question ID : 7079669414
Option 1 ID : 70796637655
Option 2 ID : 70796637654
Option 3 ID : 70796637656
Option 4 ID : 70796637653
Status : Not Answered
Chosen Option : --

Q.5
7 What is the resultant voltage generated by a 2-Li-Ion cell connected to one lead acid automobile battery in series

- Ans
- 1. 20.4 V
 - 2. 17.4 V
 - 3. 19.4 V
 - 4. 12.5 V

Question ID : 7079669382
Option 1 ID : 70796637528
Option 2 ID : 70796637526
Option 3 ID : 70796637527
Option 4 ID : 70796637525
Status : Not Answered
Chosen Option : --

Q.5
8 Which of the following converts sound signal into electrical signal?

- Ans
- 1. Microphone
 - 2. Transformer
 - 3. Speaker

4. Crystal

Question ID : 7079669423
Option 1 ID : 70796637692
Option 2 ID : 70796637691
Option 3 ID : 70796637689
Option 4 ID : 70796637690
Status : Answered
Chosen Option : 1

Q.5
9 When no ac input signals are connected to CE Transistor Load line can be plotted _____

- Ans
- 1. VCE vs VCC
 - 2. VCE vs VEE
 - 3. VCE vs Ib
 - 4. VCE vs Ic

Question ID : 7079669394
Option 1 ID : 70796637574
Option 2 ID : 70796637576
Option 3 ID : 70796637573
Option 4 ID : 70796637575
Status : Not Answered
Chosen Option : --

Q.6
0 Field Effect transistor is:

- Ans
- 1. three junction
 - 2. neither unijunction nor bijunction transistor
 - 3. unijunction transistor
 - 4. Bijunction

Question ID : 7079669403
Option 1 ID : 70796637612
Option 2 ID : 70796637611
Option 3 ID : 70796637609
Option 4 ID : 70796637610
Status : Not Answered
Chosen Option : --

Q.6
1 Which among the following is full form of SMPS

- Ans
- 1. Switch Mode Power Support.
 - 2. Single Mode Power Supply
 - 3. Switch on Mode Power Supply
 - 4. Switched Mode Power Supply

Question ID : 7079669428
Option 1 ID : 70796637710
Option 2 ID : 70796637712
Option 3 ID : 70796637711

Option 4 ID : 70796637709
Status : Answered
Chosen Option : 1

Q.6 Which among the following instruments can generate sine wave with variable frequency and amplitude?

2

- Ans
- 1. CRO
 - 2. Function generator
 - 3. LCR meter
 - 4. DSO

Question ID : 7079669387
Option 1 ID : 70796637545
Option 2 ID : 70796637546
Option 3 ID : 70796637548
Option 4 ID : 70796637547
Status : Answered
Chosen Option : 2

Q.6 The SMPS is used to transform power from AC or DC to:

3

- Ans
- 1. AC and DC load
 - 2. AC load
 - 3. RLC circuit load
 - 4. DC load

Question ID : 7079669429
Option 1 ID : 70796637715
Option 2 ID : 70796637713
Option 3 ID : 70796637716
Option 4 ID : 70796637714
Status : Not Answered
Chosen Option : --

Q.6 Scale of PMMC instrument is _____.

4

- Ans
- 1. Cubed
 - 2. 4th power
 - 3. Uniform
 - 4. Squared

Question ID : 7079669386
Option 1 ID : 70796637543
Option 2 ID : 70796637541
Option 3 ID : 70796637544
Option 4 ID : 70796637542
Status : Not Answered
Chosen Option : --

Q.6 Photo transistor is used for:

5

Ans

- 1. direct coupling
- 2. LC coupling
- 3. RC coupling
- 4. isolation

Question ID : 7079669408
Option 1 ID : 70796637629
Option 2 ID : 70796637632
Option 3 ID : 70796637631
Option 4 ID : 70796637630
Status : Not Answered
Chosen Option : --

Q.6
6 Darlington pair is used for:

- Ans
- 1. voltage and current amplification
 - 2. current amplification
 - 3. voltage amplification.
 - 4. power amplification.

Question ID : 7079669400
Option 1 ID : 70796637600
Option 2 ID : 70796637598
Option 3 ID : 70796637597
Option 4 ID : 70796637599
Status : Not Answered
Chosen Option : --

Q.6
7 What is the peak to peak voltage for an AC voltage with RMS 220 V? (Consider square root of 2 as 1.4)

- Ans
- 1. 110 V
 - 2. 616 V
 - 3. 250 V
 - 4. 308 V

Question ID : 7079669377
Option 1 ID : 70796637508
Option 2 ID : 70796637506
Option 3 ID : 70796637507
Option 4 ID : 70796637505
Status : Not Answered
Chosen Option : --

Q.6
8 Fibre optic power meters have input for attaching fibre optic connector and detector to capture:

- Ans
- 1. gama rays
 - 2. light rays
 - 3. X rays
 - 4. Ultra violet rays

Question ID : 7079669425
Option 1 ID : 70796637698
Option 2 ID : 70796637699
Option 3 ID : 70796637697
Option 4 ID : 70796637700
Status : Answered
Chosen Option : 2

Q.6 Which one of the following TV technology displays Image by blocking white light

- Ans 1. LCD TV
 2. Colour TV
 3. Portable black and white TV
 4. Black and white TV

Question ID : 7079669437
Option 1 ID : 70796637747
Option 2 ID : 70796637746
Option 3 ID : 70796637748
Option 4 ID : 70796637745
Status : Answered
Chosen Option : 1

Q.7 Schmitt trigger is used in:

- Ans 1. Hartley Oscillator
 2. Crystal Oscillator
 3. Colpitts Oscillator
 4. Relaxation Oscillator

Question ID : 7079669401
Option 1 ID : 70796637601
Option 2 ID : 70796637603
Option 3 ID : 70796637602
Option 4 ID : 70796637604
Status : Answered
Chosen Option : 1

Q.7 UJT is used to generate:

- Ans 1. sine wave
 2. square wave
 3. triangle wave
 4. sawtooth wave

Question ID : 7079669405
Option 1 ID : 70796637617
Option 2 ID : 70796637618
Option 3 ID : 70796637619
Option 4 ID : 70796637620
Status : Answered

Chosen Option : 2

Q.7
2 MOSFET has:

- Ans
- 1. low input resistance and high output resistance
 - 2. high input resistance and high output resistance
 - 3. low input resistance and low output resistance
 - 4. high input resistance and low output resistance

Question ID : 7079669406

Option 1 ID : 70796637621

Option 2 ID : 70796637622

Option 3 ID : 70796637624

Option 4 ID : 70796637623

Status : Not Answered

Chosen Option : --

Q.7
3 Which of the following converts a physical parameter to an electrical signal?

- Ans
- 1. Transformer
 - 2. Crystal
 - 3. Speaker
 - 4. Transducer

Question ID : 7079669409

Option 1 ID : 70796637635

Option 2 ID : 70796637634

Option 3 ID : 70796637633

Option 4 ID : 70796637636

Status : Answered

Chosen Option : 4

Q.7
4 What is WAN, with respect to computer network?

- Ans
- 1. Wireless Area Network
 - 2. Wide Area Network
 - 3. Wired Area Network
 - 4. World Area Network

Question ID : 7079669391

Option 1 ID : 70796637561

Option 2 ID : 70796637563

Option 3 ID : 70796637562

Option 4 ID : 70796637564

Status : Answered

Chosen Option : 2

Q.7
5 What is the voltage generated by an alkaline cell used in wall clock?

- Ans
- 1. 1.2 V
 - 2. 1.5 V

~~X~~ 3. 0.7 V

~~X~~ 4. 1.0 V

Question ID : 7079669381

Option 1 ID : 70796637523

Option 2 ID : 70796637524

Option 3 ID : 70796637521

Option 4 ID : 70796637522

Status : Answered

Chosen Option : 2